

FRONICS  
CON1  
MCD5M  
POWER

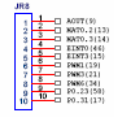

NOTE - ALL RESISTOR ,  
CAPCITOR , TRASISTOR 1206  
USE SMD PACKAGE , ALL LED  
USE SMD LED

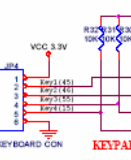
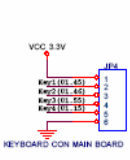
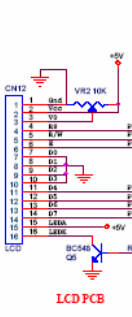
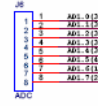
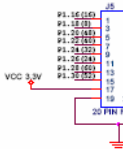
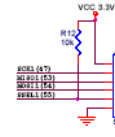
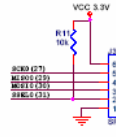
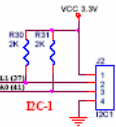
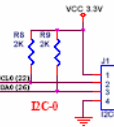
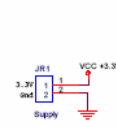
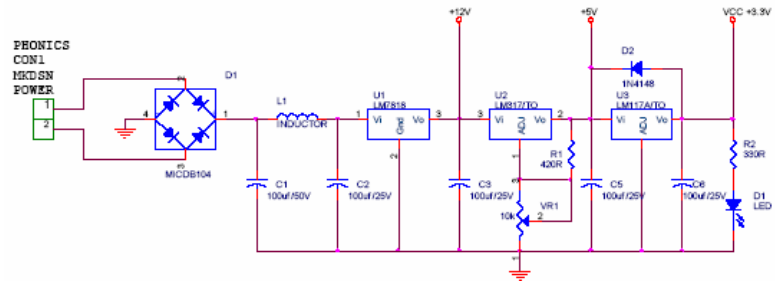
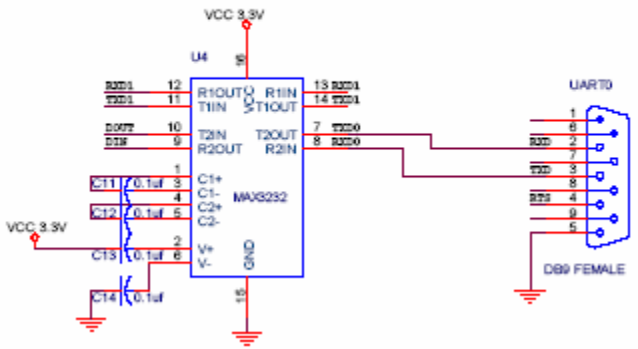

NOTE - ALL RESISTOR ,  
CAPCITOR , TRASISTOR 1206  
USE SMD PACKAGE , ALL LED  
USE SMD LED